

10' x 20'

2-IN-1 MAX AP CANOPY & EXTENSION KIT

Assembly Instructions

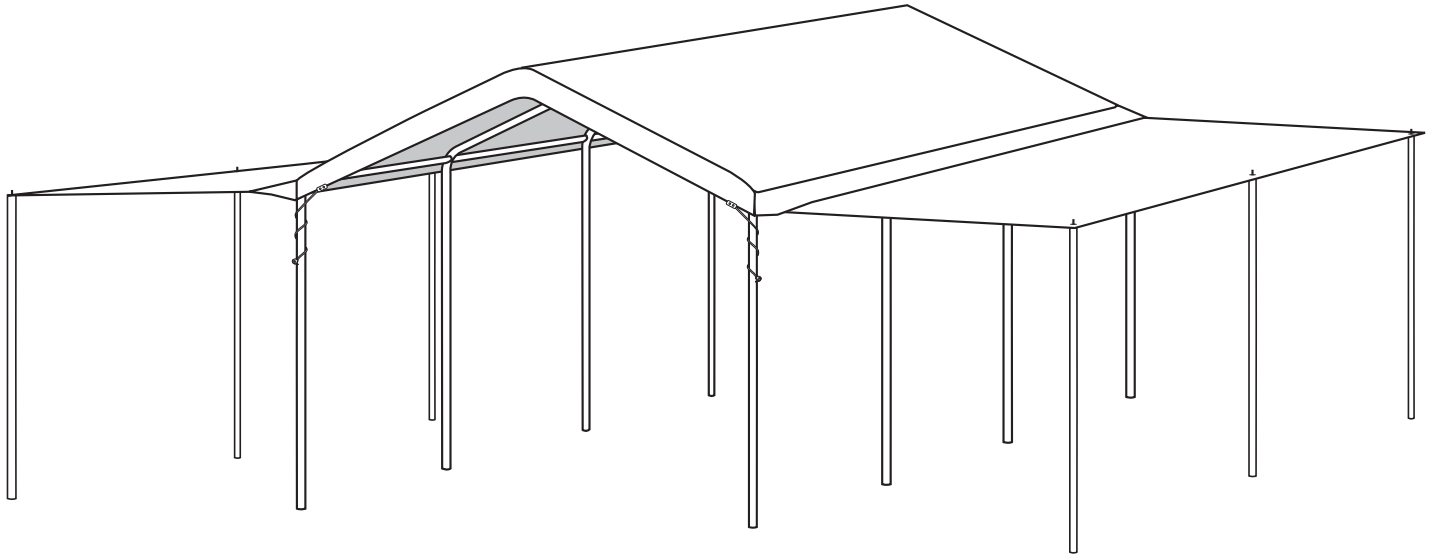

DESCRIPTION	MODEL #
10' x 20' 2-in-1 MAX AP Canopy & Extension Kit - 8 Leg - White	23530

RECOMMENDED TOOLS

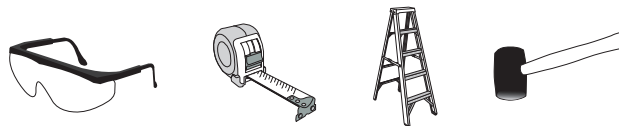

Please read instructions **COMPLETELY** before assembly. This shelter **MUST** be securely anchored. **THIS IS A TEMPORARY STRUCTURE AND NOT RECOMMENDED AS A PERMANENT STRUCTURE.**

Before you start: 2+ individual recommended for assembly, approximate time 3 hr.



150 Callender Road
Watertown, CT 06795
www.shelterlogic.com

1-800-524-9970

Canada:
1-800-559-6175

ATTENTION:

This shelter product is manufactured with quality materials. It is designed to fit the **ShelterLogic®**, LLC custom fabric cover included. **ShelterLogic®**, LLC Shelters offer storage and protection from damage caused by sun, light rain, tree sap, animal - bird excrement and light snow. Please anchor this **ShelterLogic®**, LLC structure properly. See manual for more anchoring details. Proper anchoring, keeping cover tight and free of snow and debris is the responsibility of the consumer. Please read and understand the installation detail, warnings and cautions prior to beginning installation. If you have any questions call the customer service number listed below. Please refer to the warranty card inside this package.

DANGER:

Prior to installation, consult with all local municipal codes regarding installation of temporary shelters. Choose the location of your shelter carefully. **DANGER: Keep away from electrical wires.** Check for overhead utility lines, tree branches or other structures. Check for underground pipes or wires before you dig. DO NOT install near roof lines or other structures that could shed snow, ice or excessive run off onto your shelter. DO NOT hang objects from the roof or support cables.

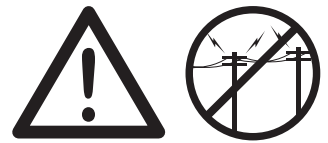

WARNING:

Risk of fire. DO NOT smoke or use open flame devices (including grills, fire pits, deep fryers, smokers or lanterns) in or around the shelter. DO NOT store flammable liquids (gasoline, kerosene, propane, etc.) in or around your shelter. Do not expose top or sides of the shelter to open fire or other flame source.



CAUTION:

Use **CAUTION** when erecting the frame. Use safety goggles during installation. Secure and bolt together overhead poles during assembly. Beware of pole ends. Use goggles when installing bungee cords. Bungee cords are under extreme tension and may cause severe injury to eyes. Please use caution when applying, as they may snap out of your hand and cause injury.

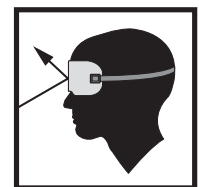

PROPER ANCHORING AND INSTALLATION OF FRAME:

PROPER ANCHORING OF THE FRAME IS THE RESPONSIBILITY OF THE CONSUMER.

ShelterLogic®, LLC is not responsible for damage to the unit or the contents from acts of nature. Any shelter that is not anchored securely has the potential to fly away causing damage, and is not covered under the warranty. Periodically check the anchors to ensure stability of shelter. The preferred anchoring system includes the use of bolted cement wedge lags for the frame. **ShelterLogic®**, LLC cannot be responsible for any shelter that blows away. **NOTE:** *Your shelter's cover can be quickly removed and stored prior to severe weather conditions.* If strong winds or severe weather is forecast in your area, we recommend removal of cover. Check with your insurance carrier for any damage as you would for any other outdoor structure or personal property claims.

REPLACEMENT PARTS, ASSEMBLY, SPECIAL ORDERS:

Genuine **ShelterLogic®**, LLC replacement parts and accessories are available from the factory, including anchoring kits for nearly any application, replacement covers, wall and enclosure kits, vent and light kits, frame parts, zippered doors and other accessories. All items are shipped factory direct to your door.

QUESTIONS - CLAIMS - SPECIAL ORDERS? CALL OUR CUSTOMER SERVICE HOTLINE:

U.S. CUSTOMER SERVICE: 1-800-524-9970 INTERNATIONAL CUSTOMER SERVICE: 001-860-945-6442 CANADA CUSTOMER SERVICE: 1-800-559-6175

HOURS OF OPERATION: MON-FRI 8:30AM-8:00PM EST, SAT-SUN 8:30AM-5:00PM EST.

CARE AND CLEANING:

A tight cover ensures longer life and performance. Always maintain a tight cover. Loose fabric can accelerate deterioration of cover fabric. Immediately remove any accumulated snow or ice from the roof structure with a broom, mop or other soft-sided instrument. Use extreme caution when removing snow from cover- always remove from outside the structure. DO NOT use hard-edged tools or instruments like rakes or shovels to remove snow. This could result in punctures to the cover. DO NOT use bleach or harsh abrasive products to clean the fabric cover. Cover is easily cleaned with mild soap and water.

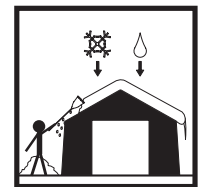

WARRANTY:











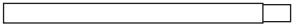
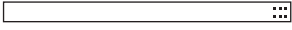

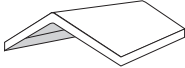
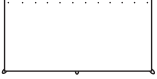

This shelter carries a full limited warranty against defects in workmanship. **ShelterLogic®**, LLC warrants to the Original Purchaser that if properly used and installed, the product and all associated parts, are free from manufacturer's defects for a period of:

1 YEAR FOR COVER FABRIC, END PANELS AND FRAMEWORK

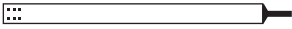
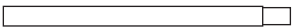
Warranty period is determined by date of shipment from **ShelterLogic®**, LLC for factory direct purchases or date of purchase from an authorized reseller, (please save a copy of your purchase receipt). If this product or any associated parts are found to be defective or missing at the time of receipt, **ShelterLogic®**, LLC will repair or replace, at its option, the defective parts at no charge to the original purchaser. Replacement parts or repaired parts shall be covered for the remainder of the Original Limited Warranty Period. All shipping costs will be the responsibility of the customer. Parts and replacements will be sent C.O.D. You must save the original packaging materials for shipment back. If you purchased from a local dealer, all claims must have a copy of original receipt. Check with your insurance carrier for any damage as you would for any other outdoor structure or personal property claim. After purchase, please fill out and return warranty card for product registration. Please see warranty card for more details.

Covered by U.S. Patents and patents pending: 6,871,614; 6,994,099; 7,296,584; D 430,306; D 415,571; D 414,564; D 409,310; D 415,572

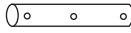
10' x 20' 2-in-1 MAX AP Canopy & Extension Kit - 8 Leg - Parts List - Model #23530

Description of Parts:		Quantity	Part #
	Rafter Poles, Swedge 24 3/8"	8	13104
	Poles, Swedge 40 11/16"	25	13103
	Cross Poles 39 1/2"	9	13107
	Leg Poles 39"	8	13105
	3 - Way Frame Connectors	6	13101
	4 - Way Frame Connectors	6	13102
	Bungee Cords	74	10066
	Canopy Cover	1	10072
	Extension Panel	2	12082
	Base Feet	8	10075
	Temporary Spike Anchors	8	10431
	Ropes 40'	2	10432
	Tent Poles 38 1/2"	6	10458
	Tent Poles, Swedge 40 3/16"	6	10459
	Bolts 1/4" x 1 1/2"	8	3025
	Wing Nut	8	7000
	Tetherball	4	10465
	"S" Hook	4	10464
	Ropes 3'	4	10463
	Temporary Spike Anchors	6	10447
	Rope Toggle	6	10436
	Clamp	8	10462
	Guy Ropes 11'	6	10437

1. LAYOUT ROOF FRAME

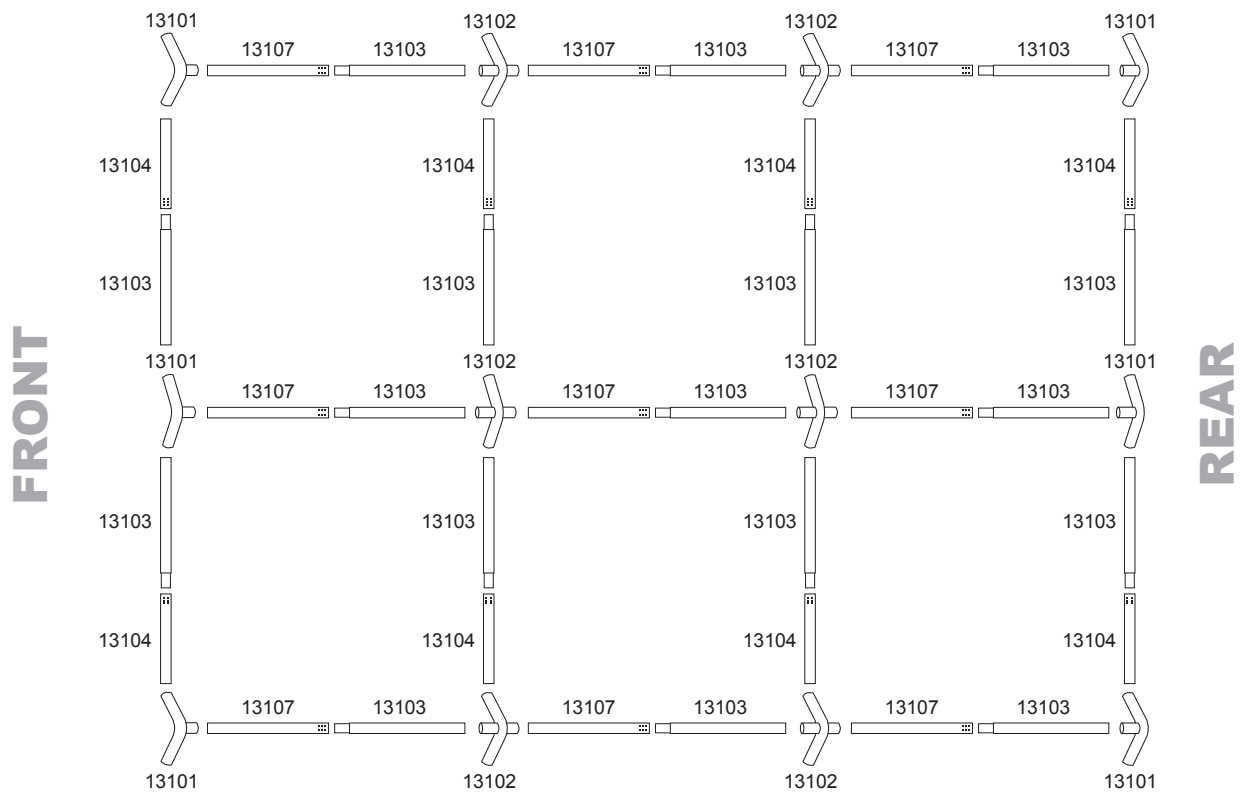

2. ASSEMBLE ROOF FRAME

NOTE: Swedged tubes insert into plain ends at the crimp marks.

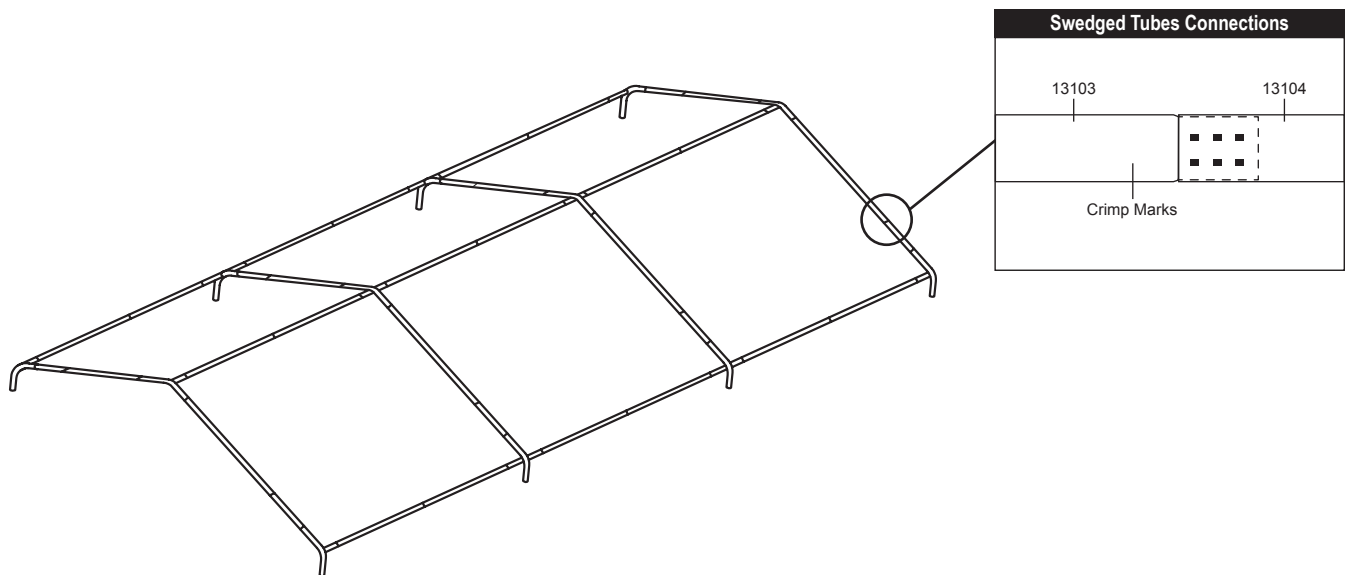

3. ASSEMBLE LEGS & ATTACH TO ROOF FRAME

A. Attach all legs to one side first. Let the other side of roof frame rest on the ground. Repeat for opposite side.

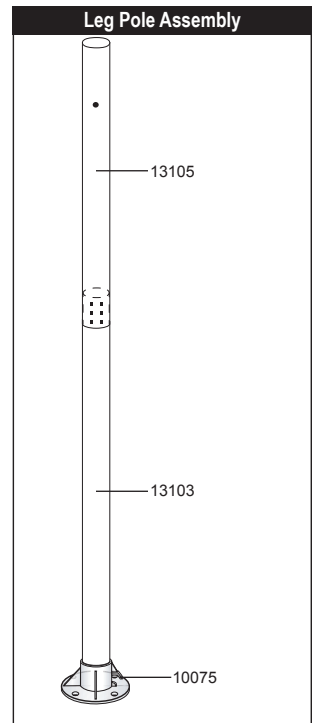
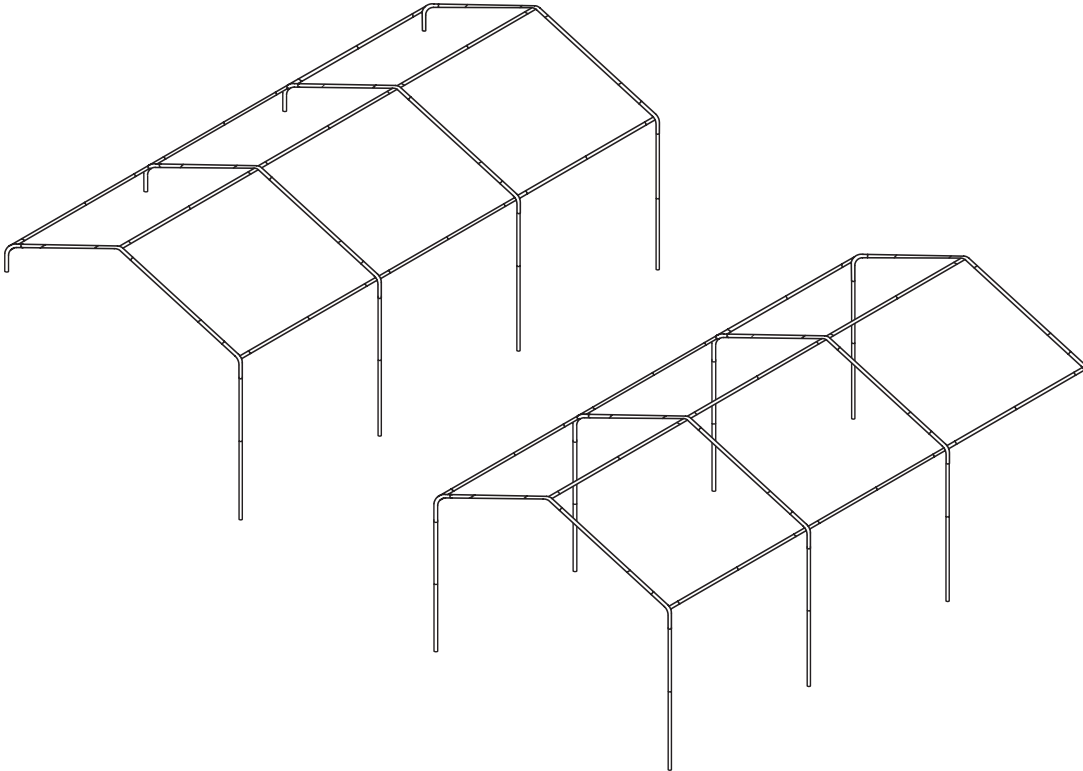

4. ANCHOR THE FRAME

Insert the (4) Anchor pins into the ground and tie ropes from the anchors to the corner tees as shown below. *These are temporary spike anchors. Not intended for permanent use.*

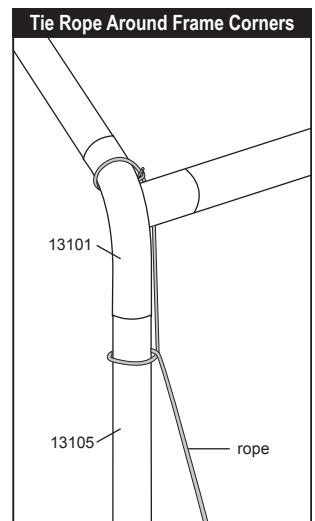
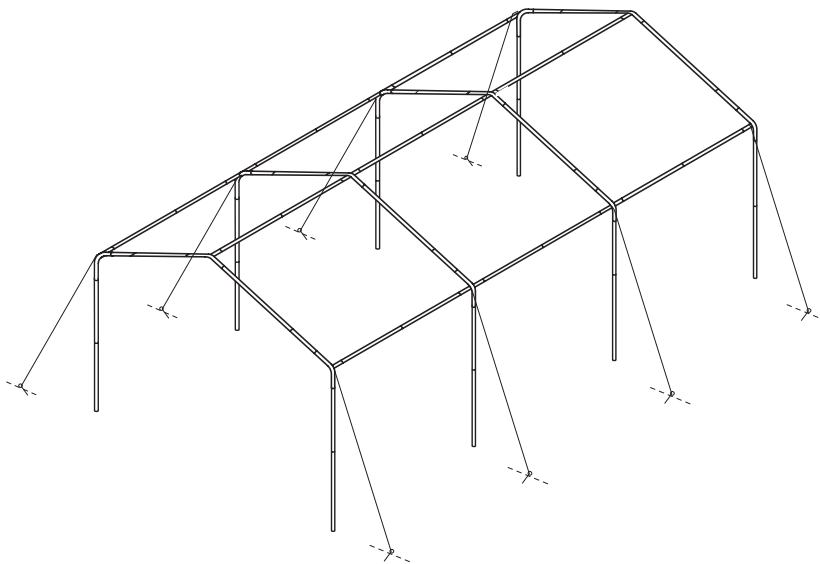

5. PLACE COVER AND SECURE TO CANOPY FRAME

- A. Place cover over assembled roof frame with grommet panels facing down, aligned with cross rails.
- B. Make sure the cover is properly aligned on the frame, secure the four corners of the cover with bungees (10066) to the frame first. Attach remaining bungees.

Re-adjust bungees position along cross pole as needed to ensure a tight and even fit of the cover to the frame.

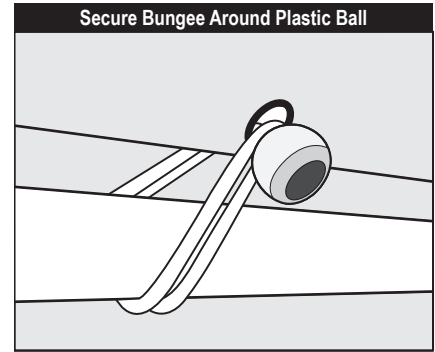
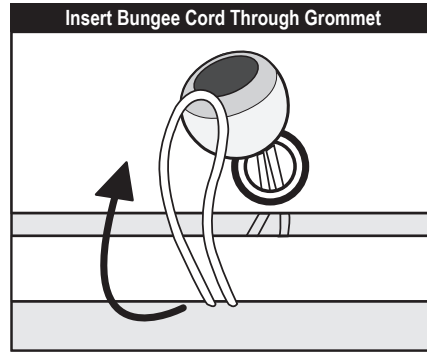
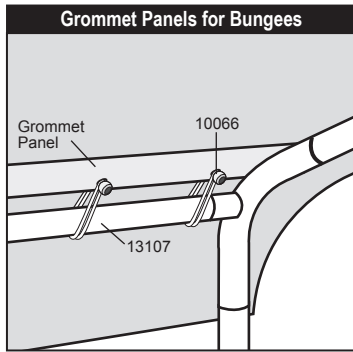
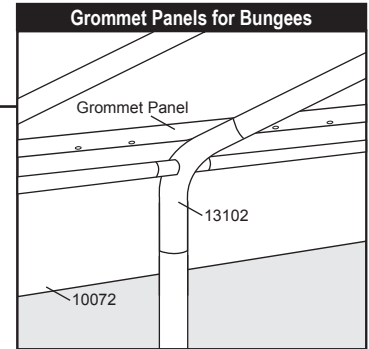
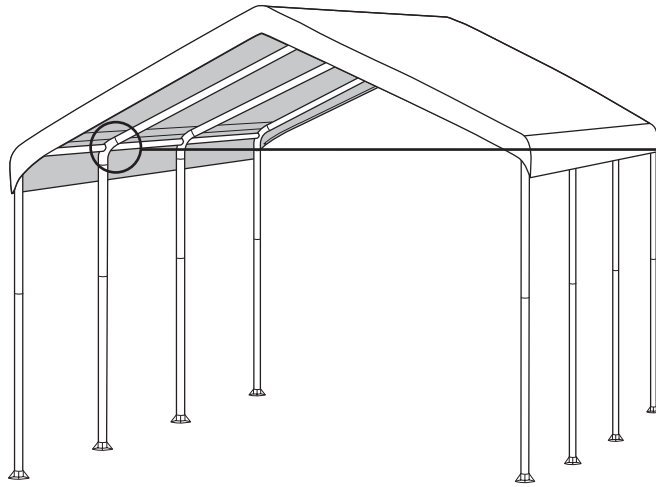

NOTES:

- Canopy extension panels attach to frame cross rails with bungee cords.
- Leave Canopy Cover bungees in place when attaching extension panels.
- Extension panels will not allow the canopy cover TwistTite mechanism to properly tighten the cover when extended. An alternate TwistTite Clamp system is included with this kit and shown in Step 5.

1. ATTACH SIDE WALLS TO FRAME

- A. If tightened at corner leg poles, disengage the TwistTite™ cord and “S” hook from canopy cover and corner legs. Wrap up TwistTite™ cord and secure inside the shelter with one of the cover panel bungee cords.
- B. Attach the extension panels with bungees to the cross rails at the top first. Adjust the panels as needed to ensure a tight and even fit before extending panel and securing to the tent poles.

CAUTION: Bungee Cords are under extreme tension. Use Caution when installing. Safety glasses are recommended to prevent injury.

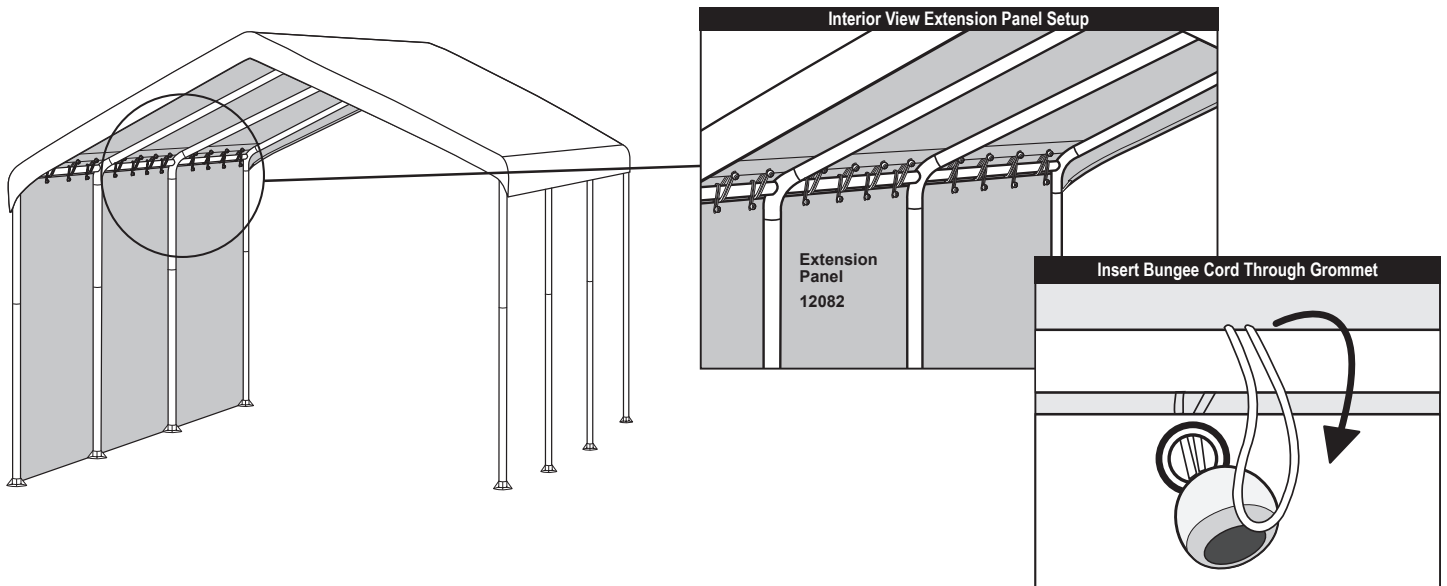

2. ASSEMBLE EXTENSION PANEL TENT POLES



3. RAISE EXTENSION PANELS AND ATTACH TENT POLES

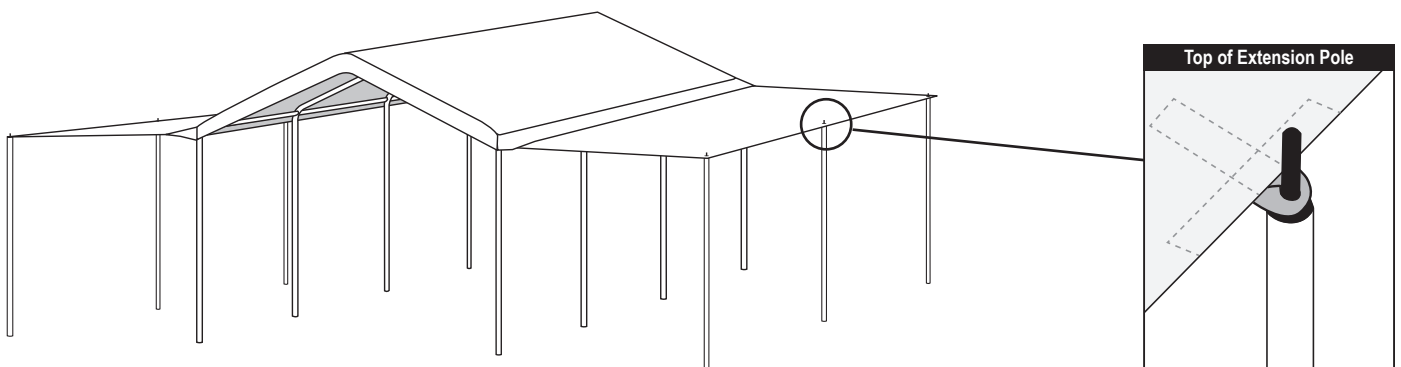

4. ANCHORING AND ROPE TOGGLES

- A. Thread the Guy Ropes 10437 through the Rope Toggle 10436 as shown below. Tie a knot at the end of the rope to keep it from sliding out of the rope toggle.
- B. Make a loop knot at the other end of the rope and place it over the tab the the top of the tent pole.
- C. Place the anchor securely in the ground about 3' from each tent pole.
- D. Tighten anchor rope with rope toggle.

This is a temporary spike anchor. Not intended for permanent use.

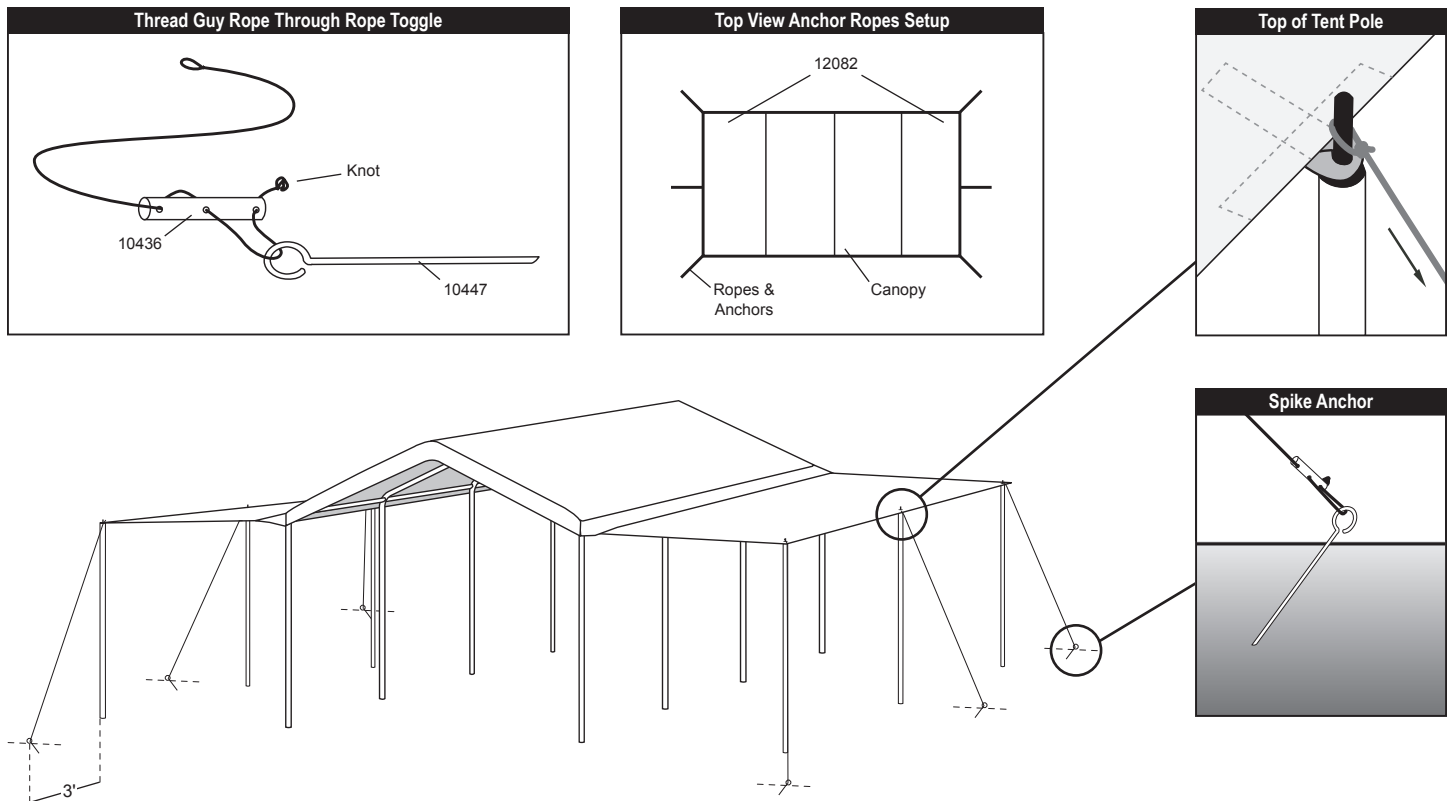

5. TIGHTEN THE COVER WITH CLAMP TWIST TITE™

- A. Mount the clamp and new TwistTite™ cable so it holds onto the rope that is still threaded through the canopy cover edges.
- B. The clamp should be mounted approximately 6" to 10" up from the corners.
- C. Wrap the cord with plastic ball and "S" hook at the corners of the cover around the corner leg poles. Insert "S" hook into the hole of the corner leg poles.
- D. Twist each leg pole toward the outside of the shelter until the cover becomes tight.

Twist the leg poles equally to ensure the cover stays aligned during tightening.

