

# Belvedere 5 Foot Octagon Steel Gazebo

Assembly Instructions

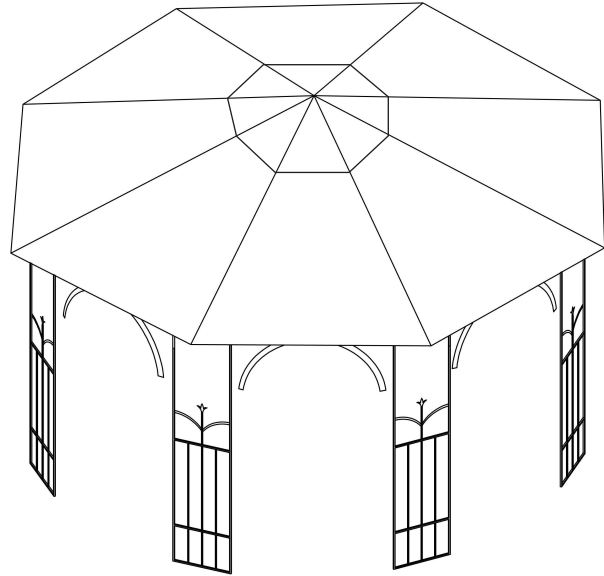







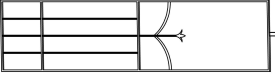

CWR049-1

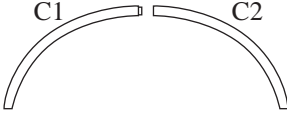

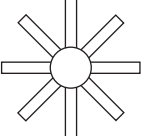
Dimensions:

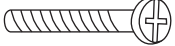
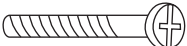
167.25"(L) x 167.25"(W) x 104.5"(H)

## PARTS LIST:

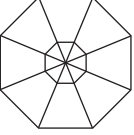
<p>(A) Screen Qty: 8 78.7" x 16.1" x 0.8"</p> 	<p>(B) Beam Qty: 8 45.3" x 4.7" x 4.7"</p> 	<p>(C) Arch Qty: 16 33.5" x 0.7" x 8.3"</p> <p>C1 C2</p> 	<p>(D) Rib Qty: 8 43.7" x 0.7" x 0.7"</p> 
<p>(E) Rib Qty: 8 44.5" x 0.7" x 0.7"</p> 	<p>(F) Hub Qty: 1 8.7" x 8.7" x 2.75"</p> 	<p>(G) Connector Qty: 16 5.1" x 0.8" x 0.8"</p> 	<p>(H) Bold Qty: 72 30mm Long</p> 
<p>(I) Bold Qty: 16 38mm Long</p> 	<p>(J) Bold Qty: 16 50mm Long</p> 	<p>(K) Ground Nail Qty: 16</p> 	<p>(L) Nut Qty: 104</p> 
<p>(M) Cover Qty: 1 228.3" x 228.3"</p> 	<p><b>Manufacturer Recommendation :</b></p> <ol style="list-style-type: none"> <li>1) <b>KEEP CHILDREN AWAY</b> ,Children should not be allowed in the working area. Do not let them handle parts and tools .</li> <li>2) <b>USE CAUTION</b> , During all the processes of assembling, especially when lifting heavy or large parts, pay attention to safety .</li> </ol> <p>It is recommended to remove the canopy during inclement weather .</p>		

## Note :

This Gazebo is meant to be used for decorative and sunshade purposes only .

This is not meant to withstand all elements of the weather .

Please read drawings carefully before assembling

- 1) Do not cook underneath Gazebo .
- 2) Do not ignite fireworks underneath Gazebo .
- 3) This product is designed for leisure use only and is not a shelter against adverse weather conditions.

### STEP 1

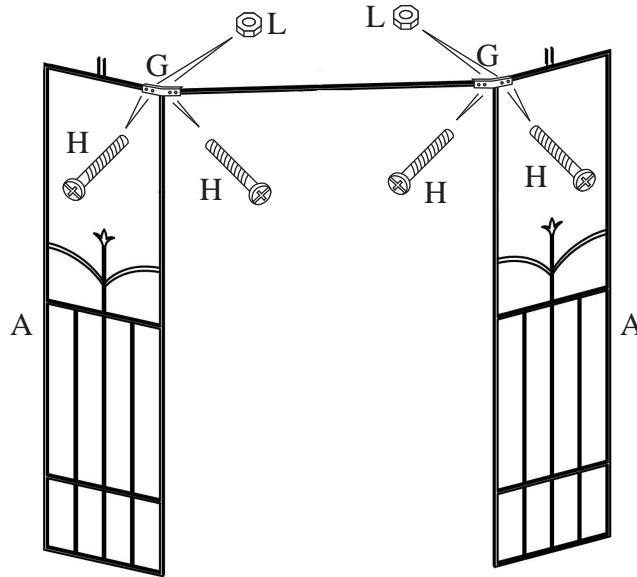

### STEP 2

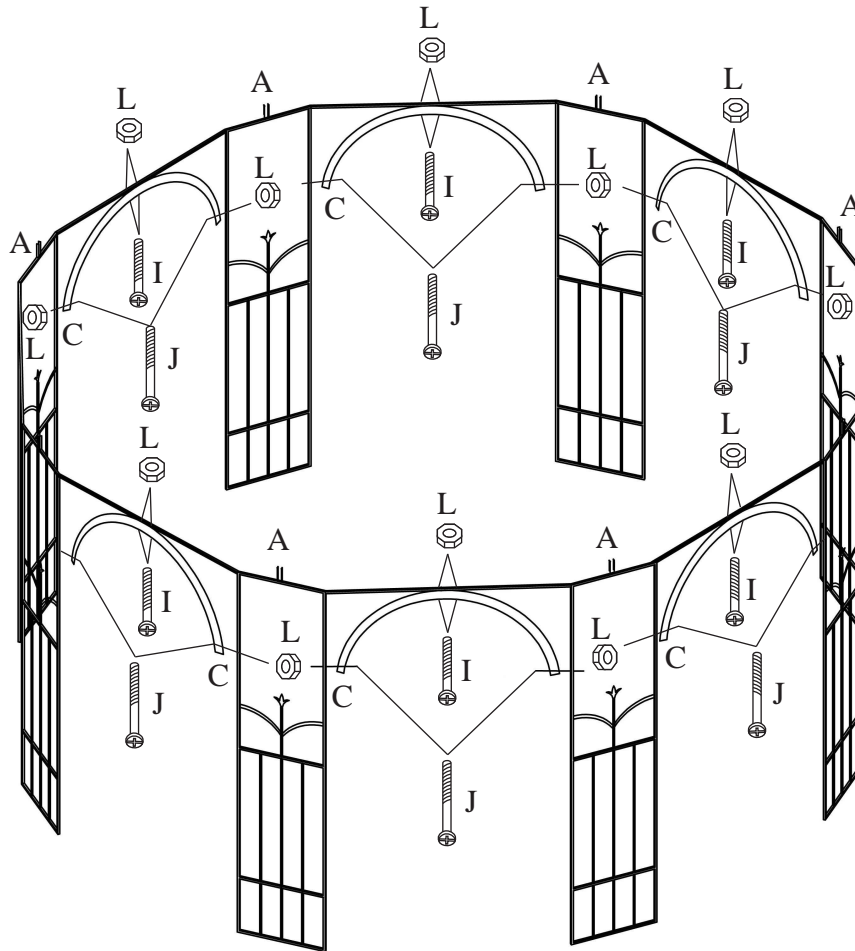

### STEP 3



**STEP 4**

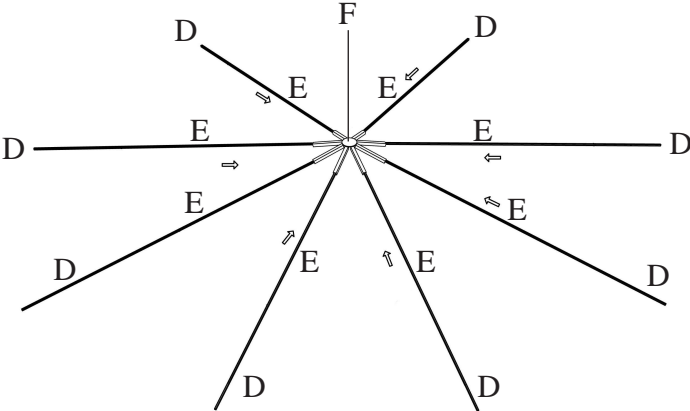

**STEP 5**

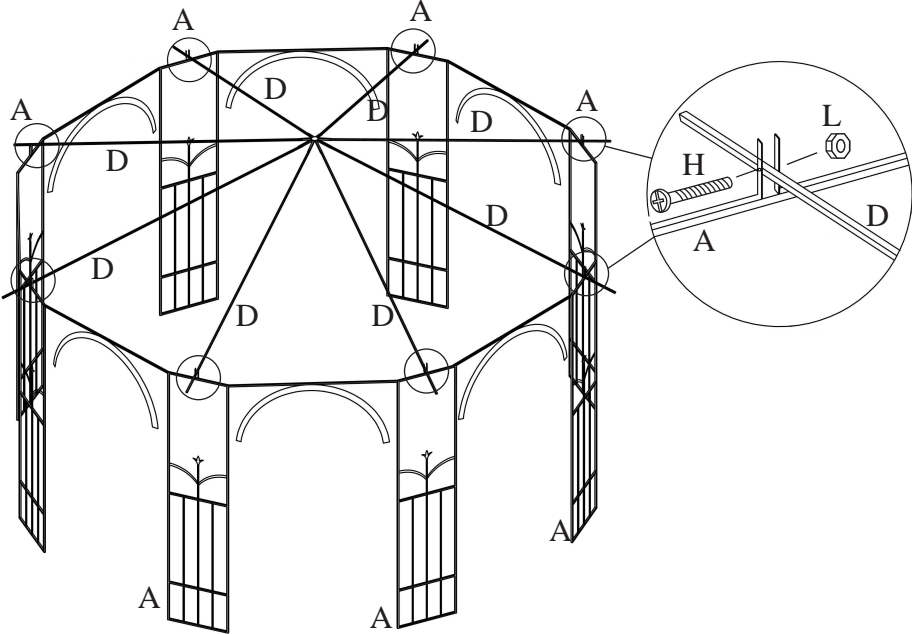

**STEP 6**

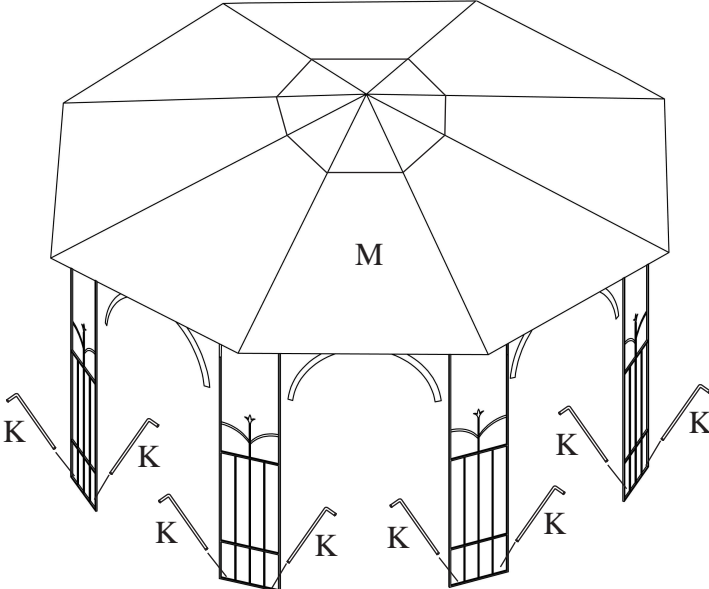

\*\* BE SURE ALL FASTENERS ARE FULLY TIGHTENED BEFORE USING THE ITEM.  
PAGE 3 OF 3